



Scientific and Technical Research
Center on Arid Regions. **(CRSTRA)**
UNIVERSITY OF BISKRA . ALGERIA.



BISKRA UNIVERSITY



International School of Hydraulics
23-26 May 2023
KATY RYBACKIE • POLAND



International Association for
Hydro-Environment Engineering
and Research **(IAHR)**

DISCHARGE CAPACITY OF AN IMPROVED FORM OF LABYRINTH WEIR

Presenter

Ben Saïd Mosbah

Authors Ben Saïd Mosbah and Ouamane Ahmed

E-mail of the presenter : bensaid.mosbah@crstra.dz
bensaid.mosbah@gmail.com

Contents

- Introduction
- Research objectives
- Experimental Model
- Numerical Model
- Results and discussion
- Conclusion

Introduction



Labyrinth Weir

Introduction



Piano Key Weir

Introduction

- Increasing the discharge capacity
 - Lowering the crest level

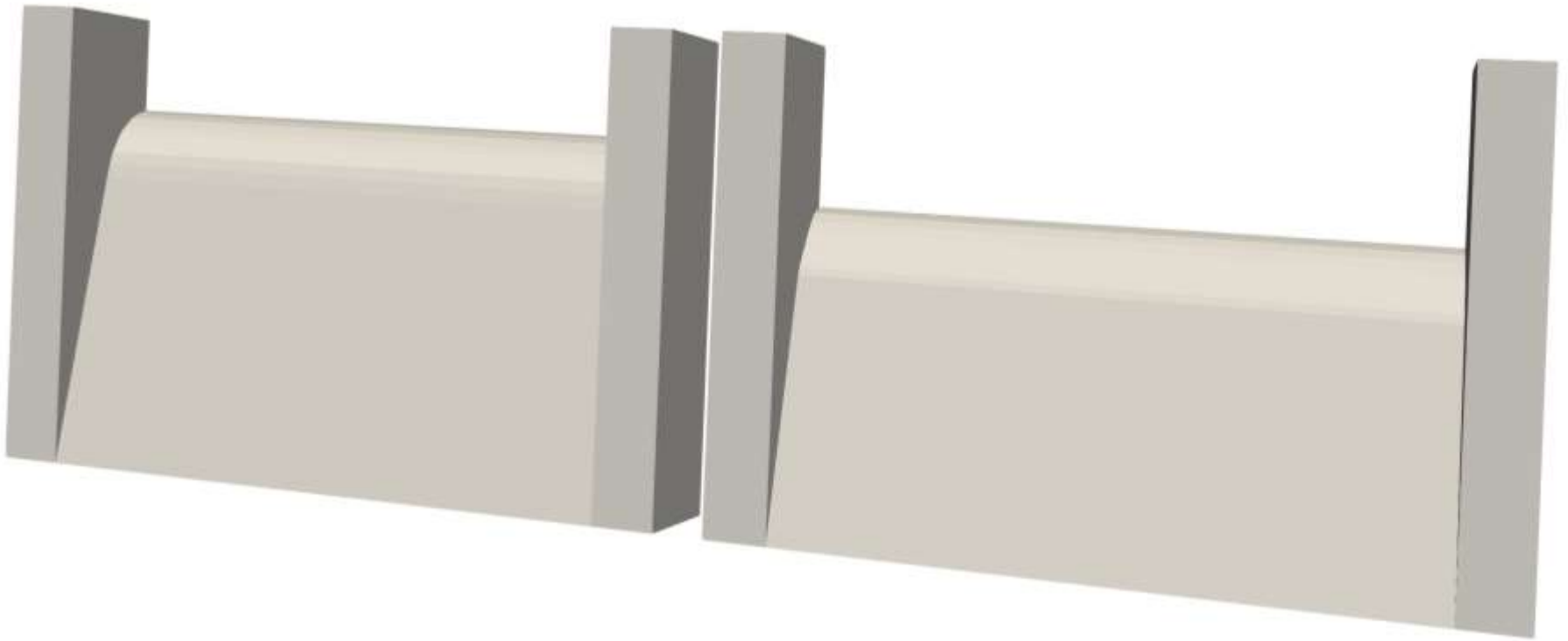

Linear Weir

Introduction

- Increasing the discharge capacity
 - Crest length

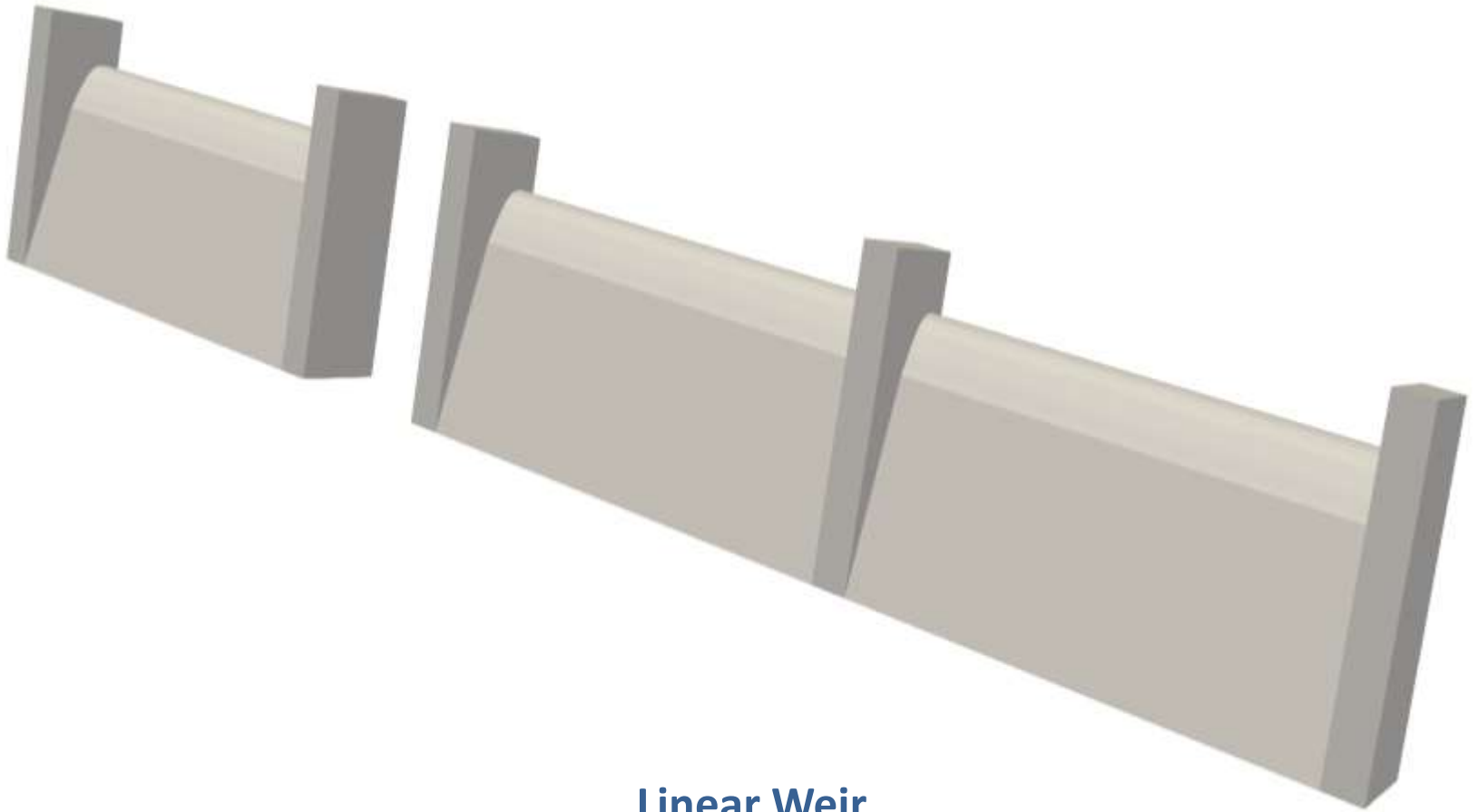

Linear Weir

- Free surface weir capacity

$$Q = C\sqrt{2g}H^{\frac{3}{2}}L$$

$$Q = C\sqrt{2g}H^{\frac{3}{2}}L$$

$$Q = C\sqrt{2g}H^{\frac{3}{2}}L$$

Q = discharge
L = Crest length

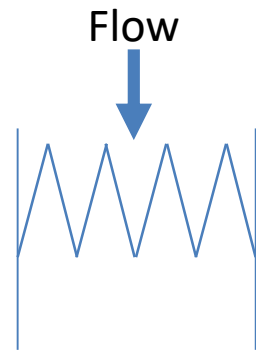
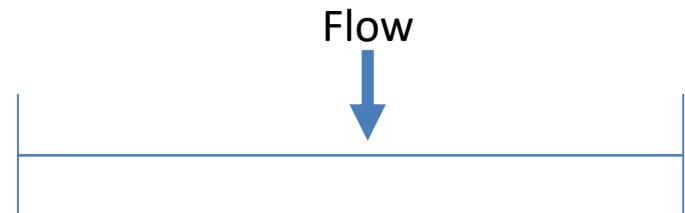
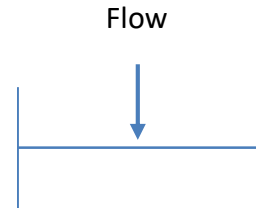

Introduction

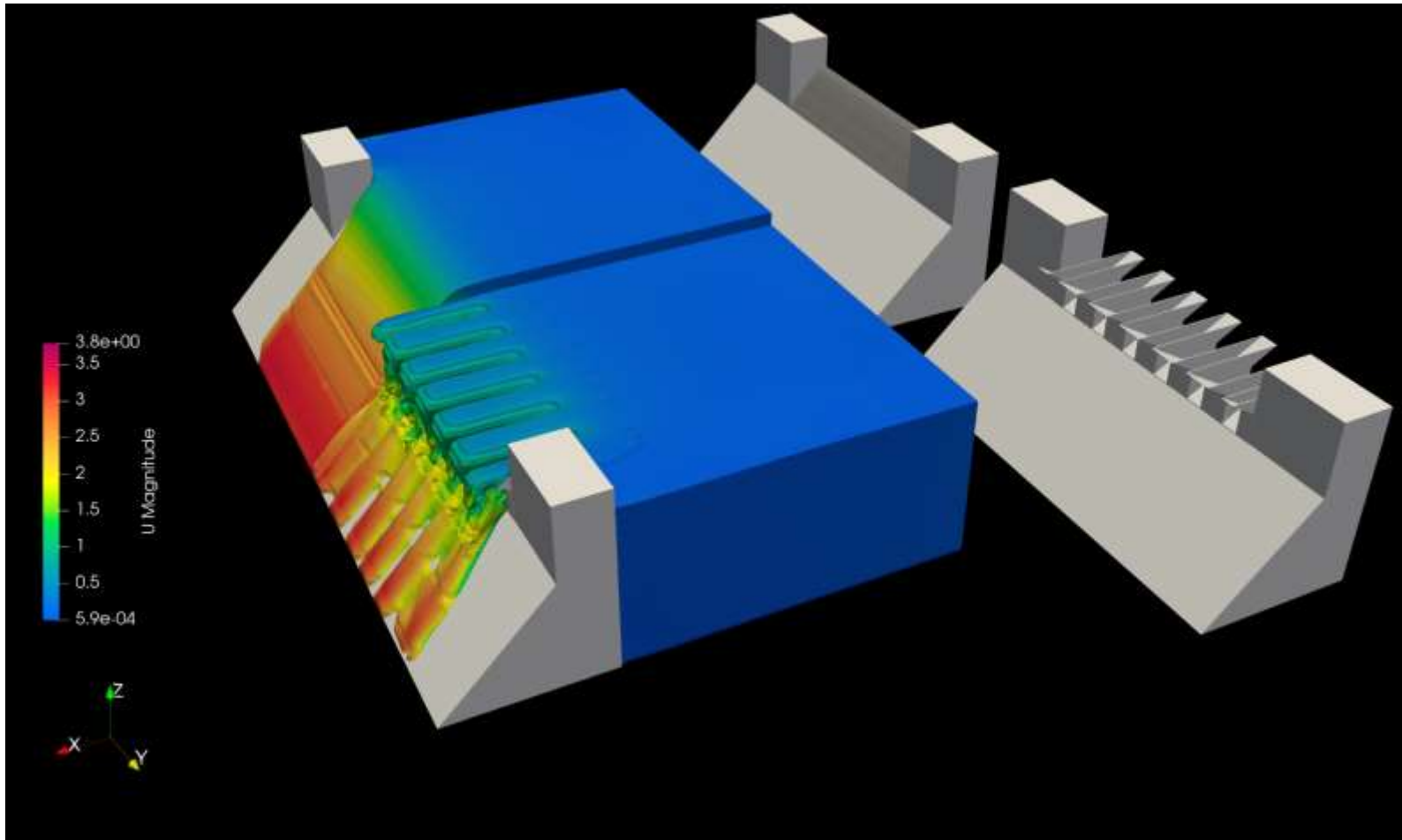

Comparison between non-linear weir and linear weir for the same discharge Q and spillway width

Introduction

- Bakheda Dam in Algeria 1936 - 1960



**Bakhada Dam with linear weir-
Before 1960**



**Bakhada Dam with Nonlinear weir-
After 1960**

Introduction

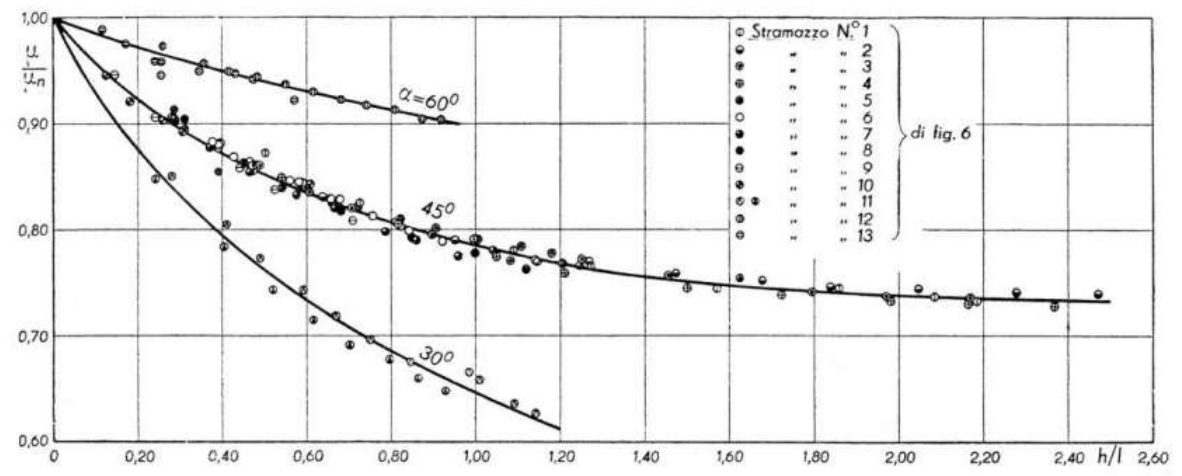
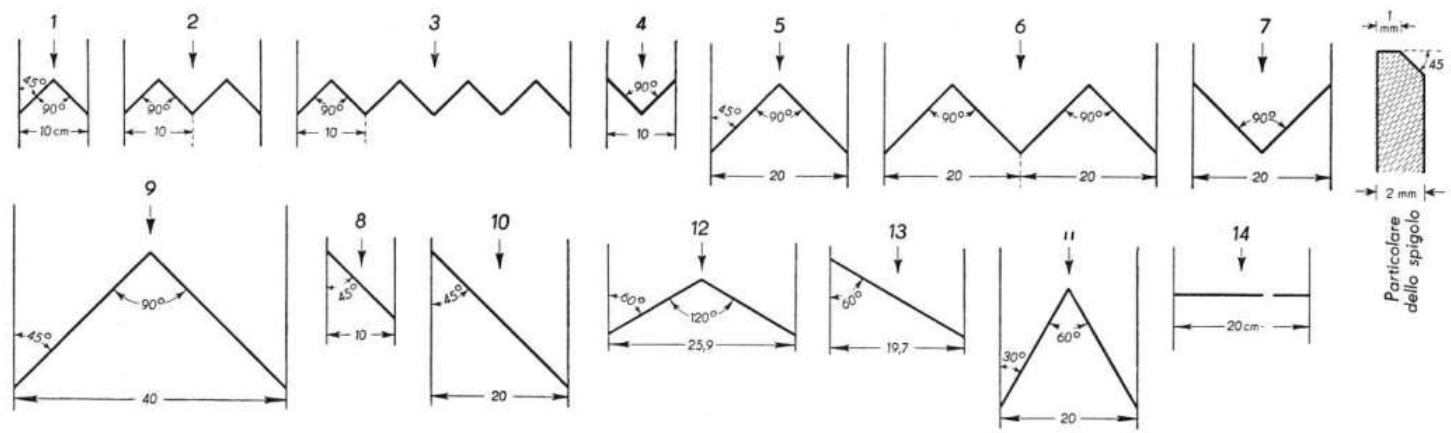

Bruno Gentilini (1941)
(Polytechnic School, Milan)

Introduction

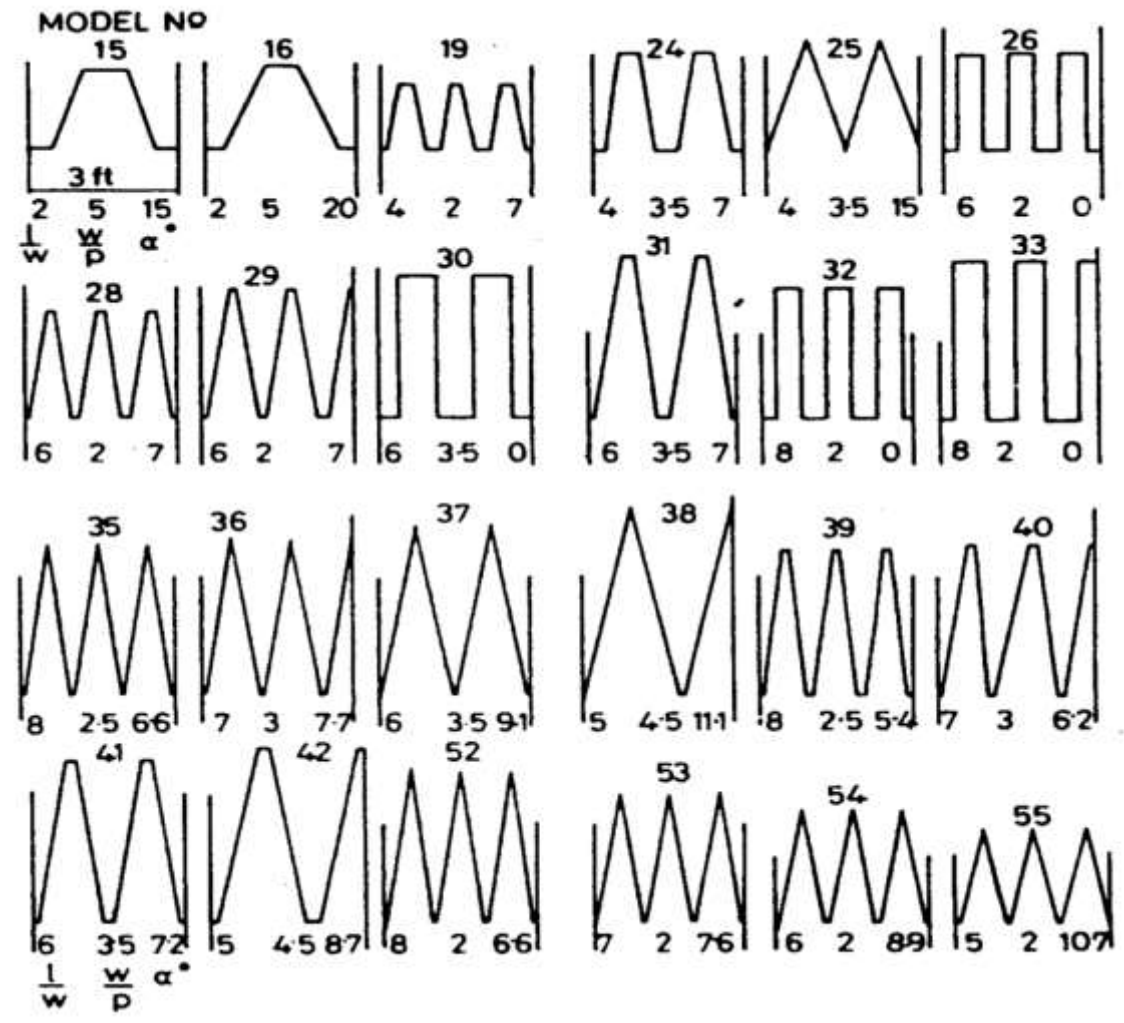

Labyrinth weirs studied by Hay and Taylor (1970)

Introduction

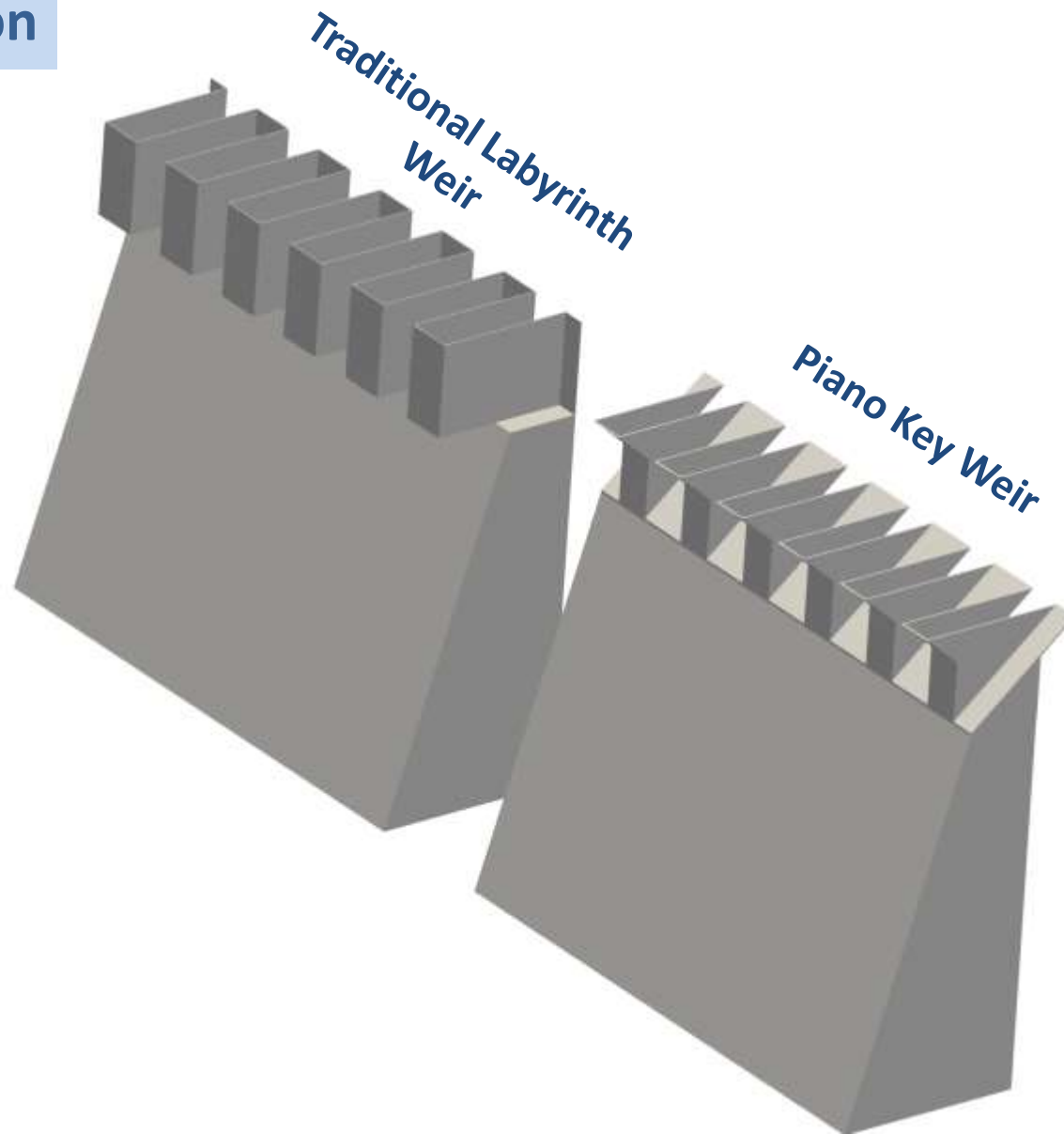

P.K. Weir represent a new type of labyrinth weir (developed by Hydrocoop France and Biskra University Algeria (2003))

Introduction

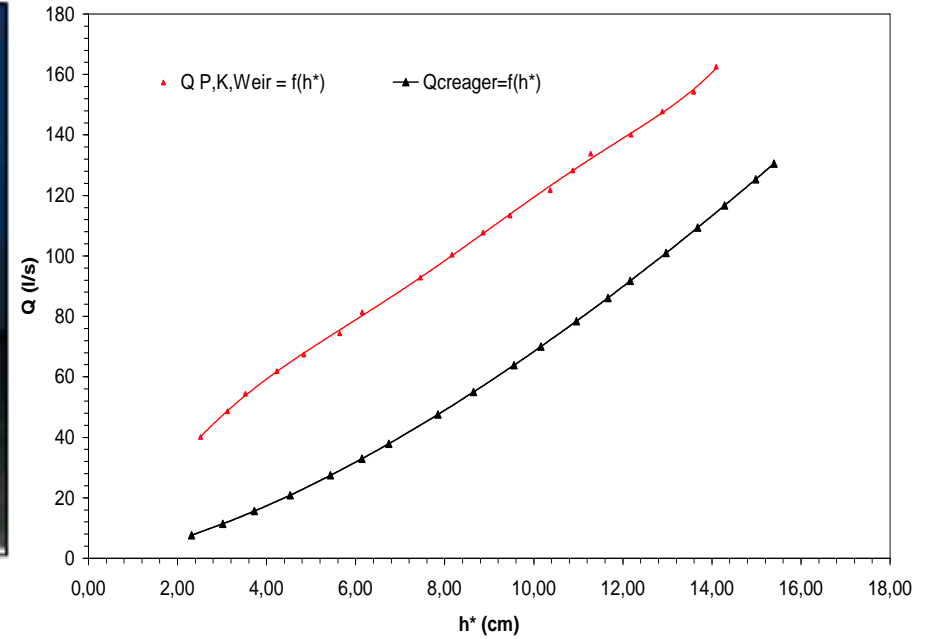
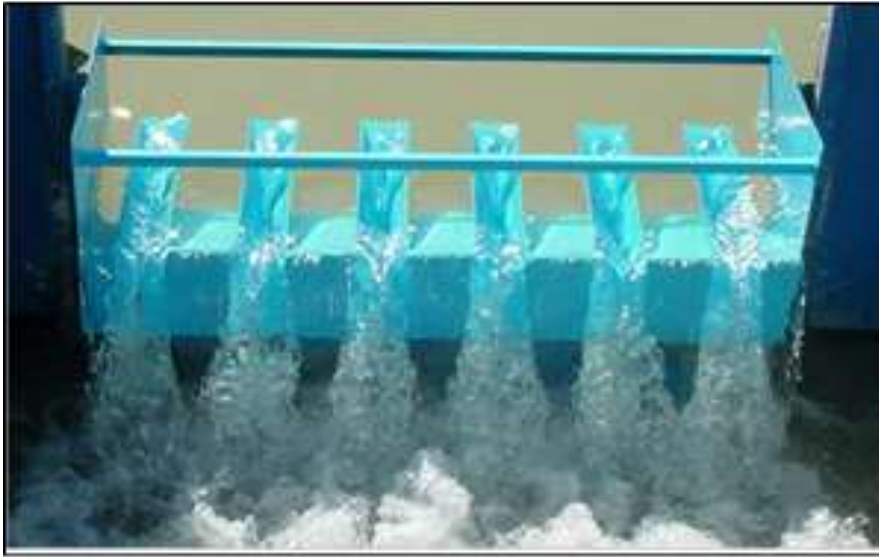

Piano Key Weir performance compared to linear weir

Introduction

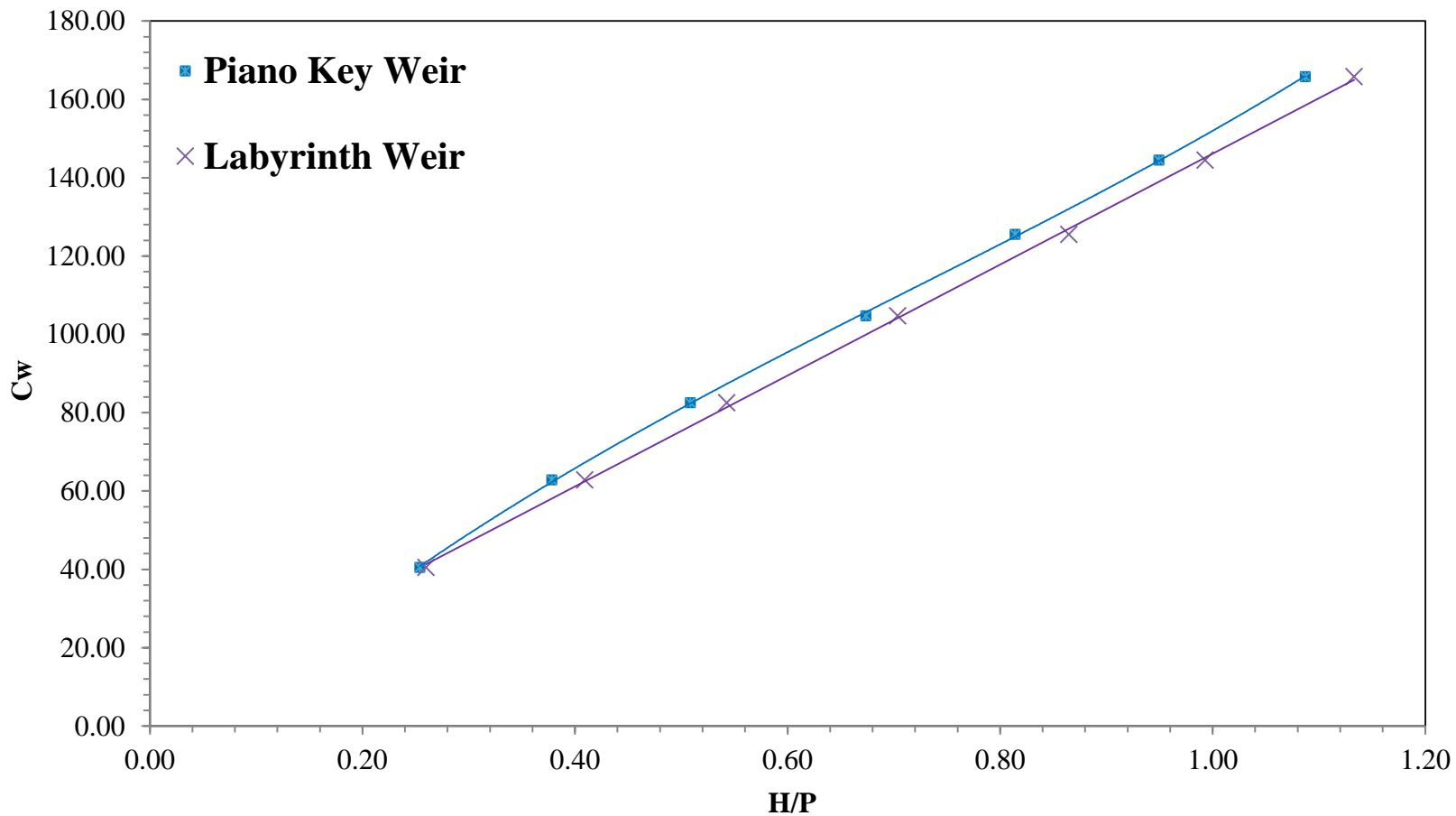

Piano Key Weir performance compared to linear weir

The Piano Keys weir: a new cost-effective solution for spillways

E. Lempérière, Hydrocoop, France
A. Ouamane, Biskra University, Algeria

Free-flow spillways are simpler and safer than gated ones, but the low specific flow of their traditional shapes requires high spilling nappe depths and thus huge losses of storage ($100 \times 10^9 \text{ m}^3$ worldwide). A new shape of free-flow spillway (the "Piano Keys weir") can increase the specific flow fourfold or more. It could substantially reduce the cost of most new dams and increase, at low cost, the safety and the storage and/or the flood control efficiency of many existing dams.

Most existing free-flow spillways have a standardized shape (Creager weir) and are placed upon concrete gravity dam structures. Their drawback is their low specific flow which is (in $\text{m}^3/\text{s}/\text{m}$) close to $2.2 h^{1.5}$ (h being the nappe depth in metres).

Consequently, the loss of live storage corresponding to the maximum nappe depth may be 20 to 50 per cent, compared with a gated reservoir, even if using longer spillways than with gates.

It is thus very advantageous to increase the specific flow as much as possible. Some tens of existing spillways have been designed accordingly as vertical walls on a flat bottom, with a trapezoidal labyrinth layout which is much longer than the spillway length (often four times.) They usually double the specific flow of a Creager weir. They require 1 or 2 m^3 of reinforced concrete to increase the flow by 1 m^3/s , and have mainly been used for specific flows in the range of 10 $\text{m}^3/\text{s}/\text{m}$. Exceptionally, the Ute dam in USA increased the specific flow by 30 $\text{m}^3/\text{s}/\text{m}$; it required 60 m^3 of reinforced concrete per meter. Apart from its cost for high flows, the main drawback of the traditional labyrinth solution (vertical walls and flat bottom) is that it cannot be used on top of the usual concrete gravity dam sections and requires a substantially flat area. It can therefore only be used for a few dams and in fact has been used for one per thousand large dams.

Model tests for the P.K. weir at the French national hydraulic laboratory LNH (owned by Electricité de France).

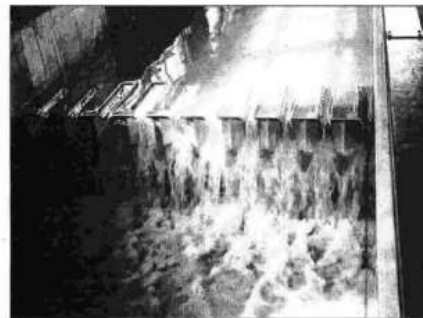

1. The P.K. weir design

A totally different design has been studied for five years by Hydrocoop (a non-profit-making international association), and this has been supported by more than 50 hydraulic tests. The target is a structure which:

- can be placed on existing or new gravity dam sections;
- will allow for specific flows of up to 100 $\text{m}^3/\text{s}/\text{m}$;
- can multiply at least by four the flow of a Creager weir; and,
- is structurally simple, and easy to build with the local resources of all countries.

Preliminary model tests were done in 1999 at the LNH Laboratory in France (owned by Electricité de France) and in 2002 at Roorke University in India and Biskra University in Algeria. Some shapes were then selected, and are based on:

- a rectangular layout somewhat similar to the shapes of piano keys which explains the name "Piano Keys weir" (thus "P.K. weir");
- an inclined bottom of the upstream and downstream part (the part where the flow enters is known as the inlet, and the other part the outlet); and,
- a reduced width of the elements.

Many detailed tests were then done in 2003 on selected shapes at Biskra University and some tests using a very wide flume at LNH.

These detailed tests provided the basis for optimizing the flow increases according to the ratios between length, depth, width and shape of the elements, and particularly according to the ratio (length of walls/length of spillway) N .

The impact of various overhangs has also been studied. Particular attention has been paid to the structural design and construction facilities for selecting the most attractive solutions.

Very simple longitudinal sections have at present been preferred: it is possible that refining these shapes may slightly improve the cost efficiency.

Further studies are now under way in China (at IWHR in Beijing) and India (Roorke University) as there are great possibilities for using P.K. weirs in these two countries.

Hydraulic and structural data are given next for two solutions.

- *Solution A*, with similar upstream and downstream overhangs; this favours the use of precast concrete elements, which may be used for specific flows of up to about 20 $\text{m}^3/\text{s}/\text{m}$. It may be preferred for this reason to improve many existing spillways.

Reprinted from: *Hydropower & Dams* Issue Five, 2003

First publication (2003)



Goulours dam (France, 2006)



Ouldjet Melleg dam (Algeria, 2006)

Introduction



Van Phong dam dam (Vietnam, 2016)

Introduction



West Fork Eno Reservoir (USA, 2021)

Introduction

- Evaluation of the influence of the main parameters on P.K. Weir capacity

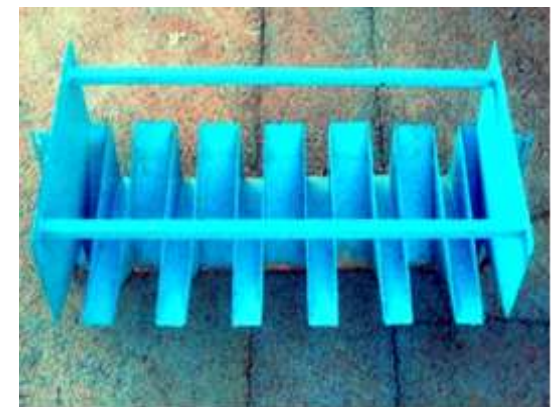
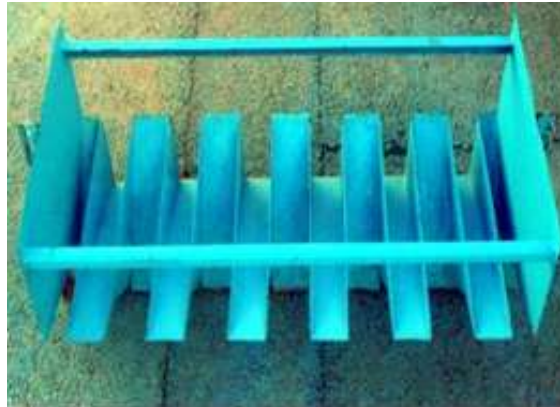
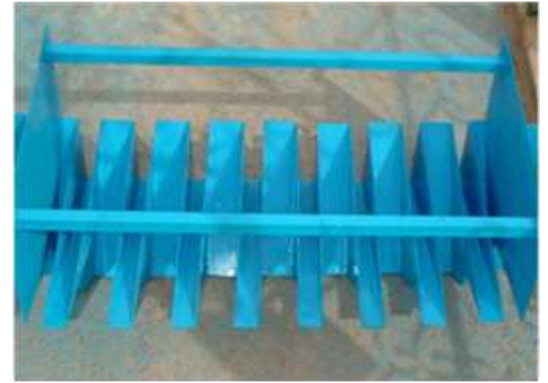
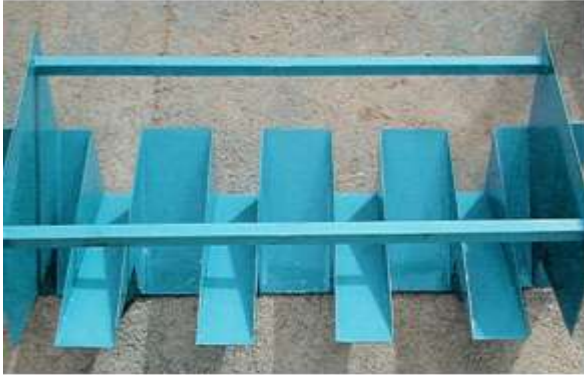

Experimental Models

Introduction

- Evaluation of the influence of the main parameters on P.K. Weir capacity

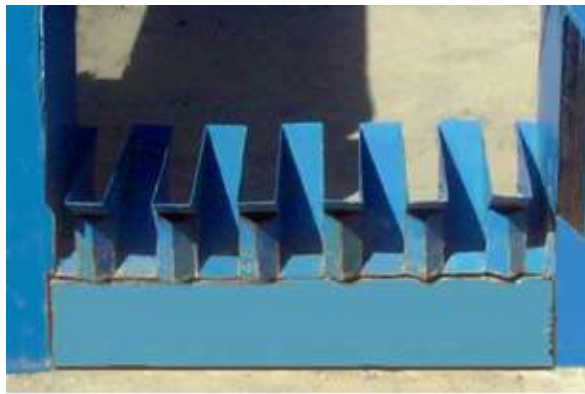

Experimental Models

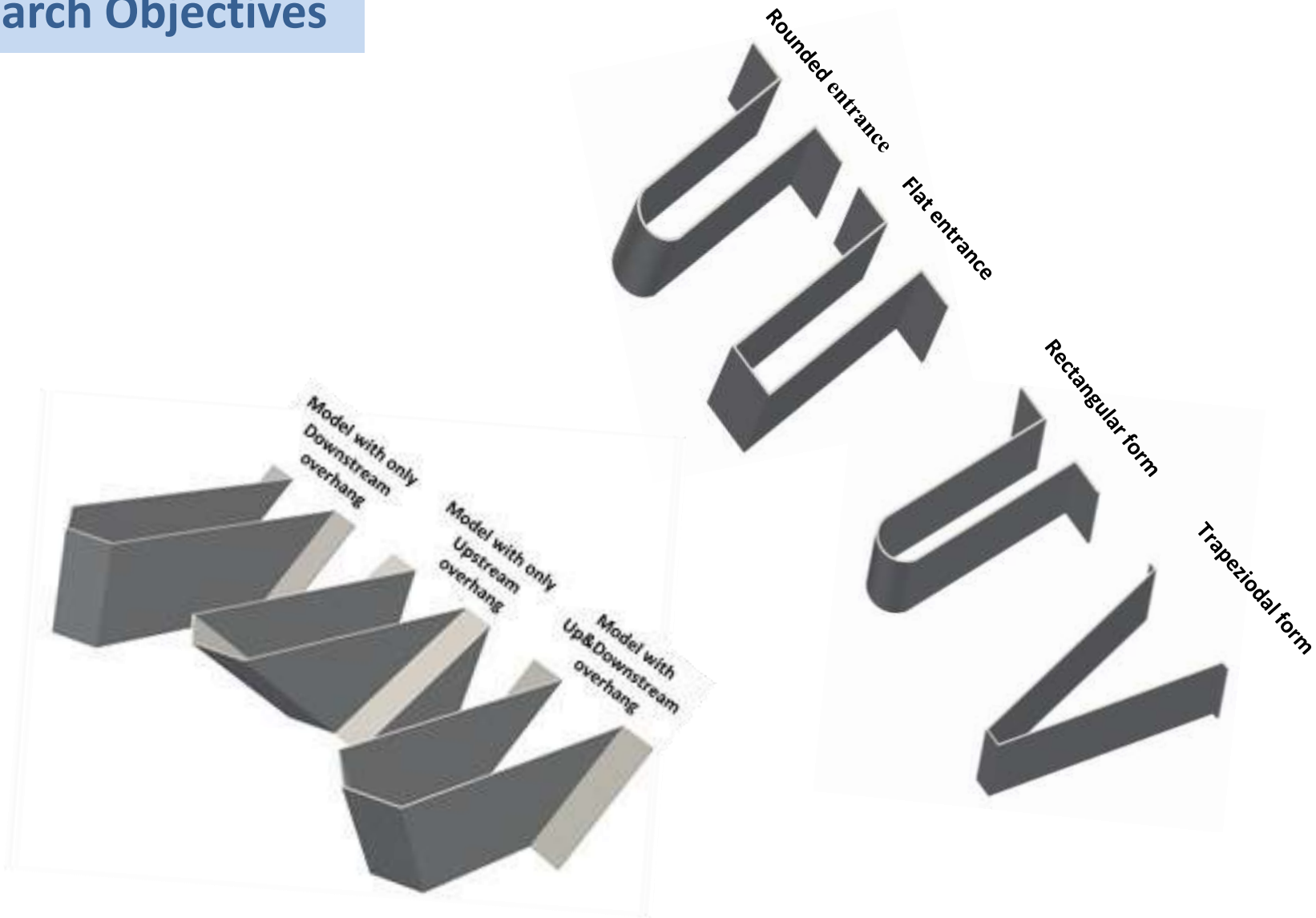

Geometries of studied models

Experimental method



Experimental station

- Flow behavior over the tested models



Flat entrance



Rounded entrance



Trapezoidal form



**Model UP&Downstream
overhangs**



**Model with only Upstream
overhangs**



**Model with only Downstream
overhangs**

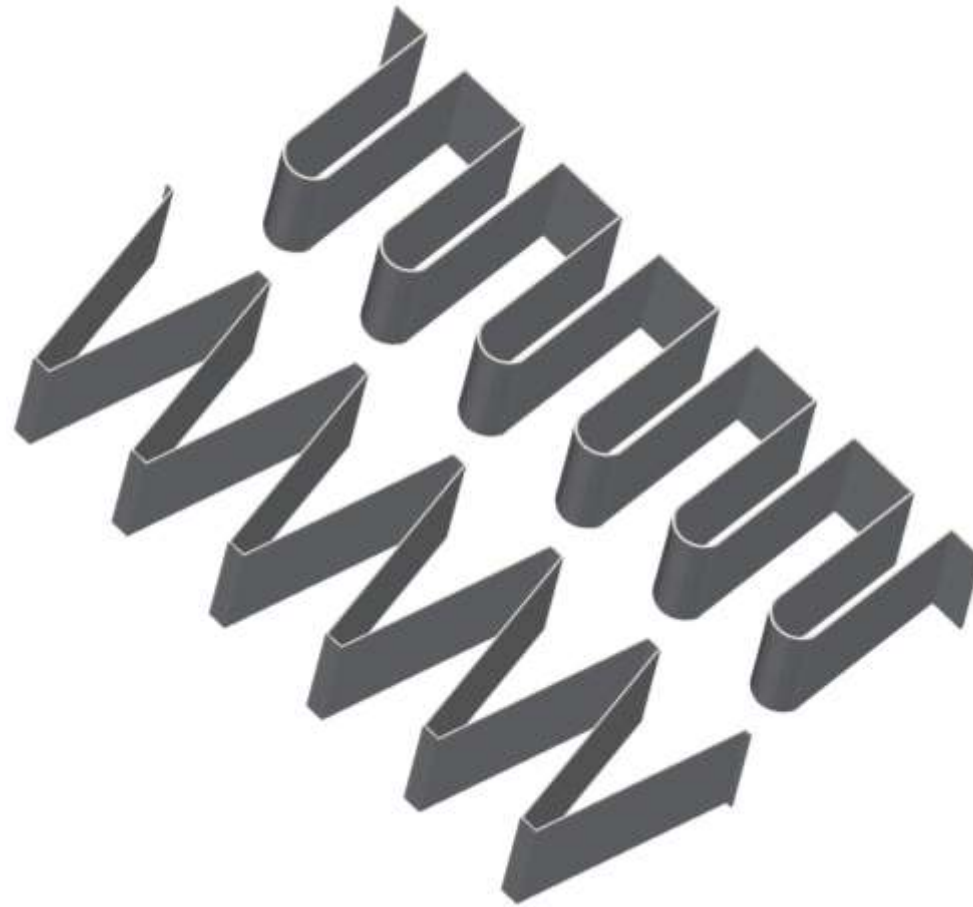

**Geometry of the simulated models of labyrinth, (a)
Rectangular Labyrinth (b) Trapezoidal Labyrinth**

Numerical Model

Computational Model :

- **InterFoam** solver and the **k- ϵ** turbulence model were used
- **blockMesh** and **snappyHexMesh** have been used to discretize the computational domain and a grid mesh of around 200 000 cells was generated.

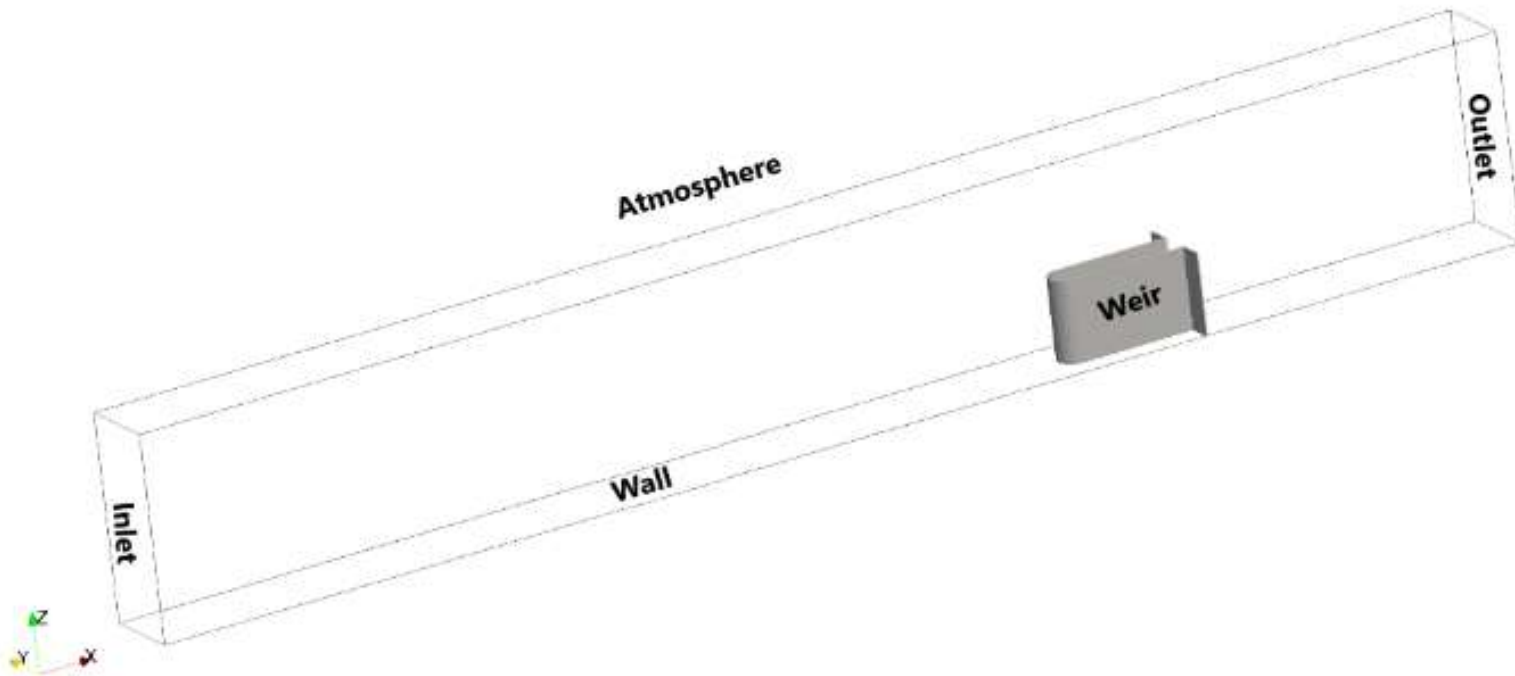

Numerical model mesh and boundary surface

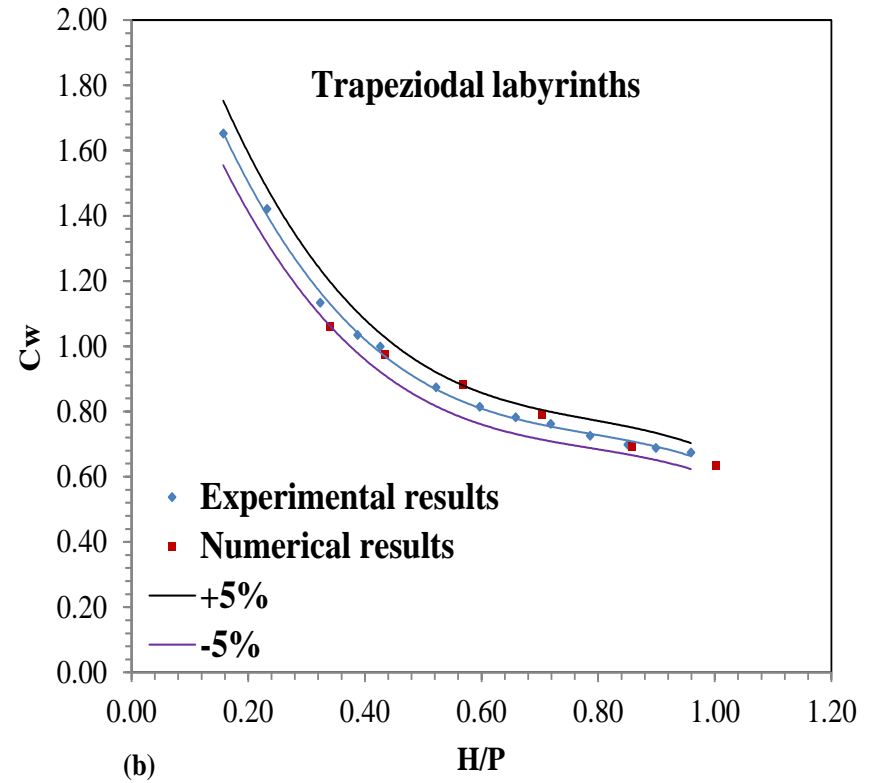
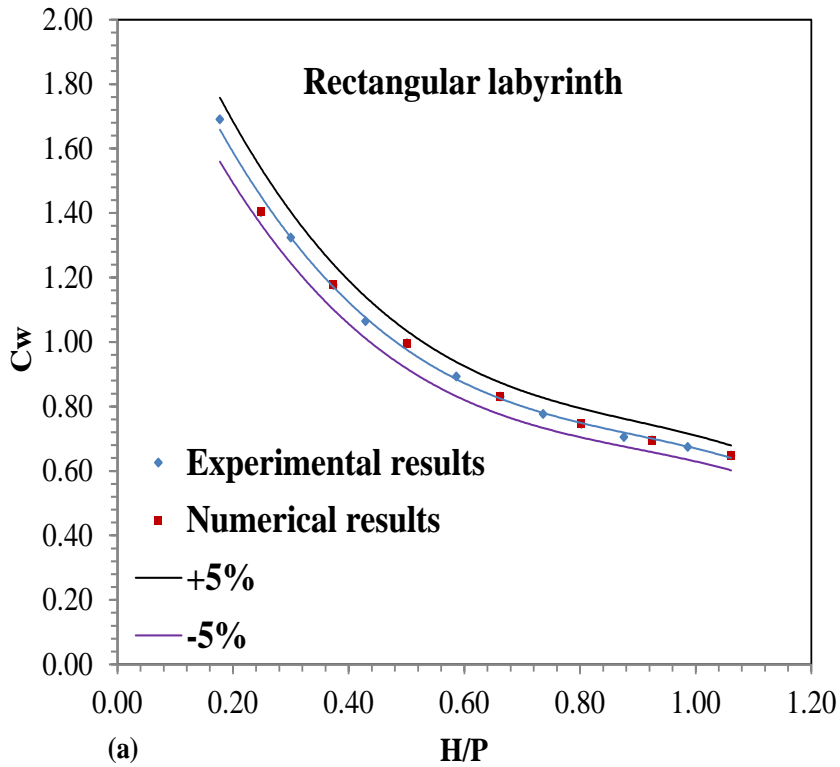

Comparison between experimental and numerical results

- Entrance Effect

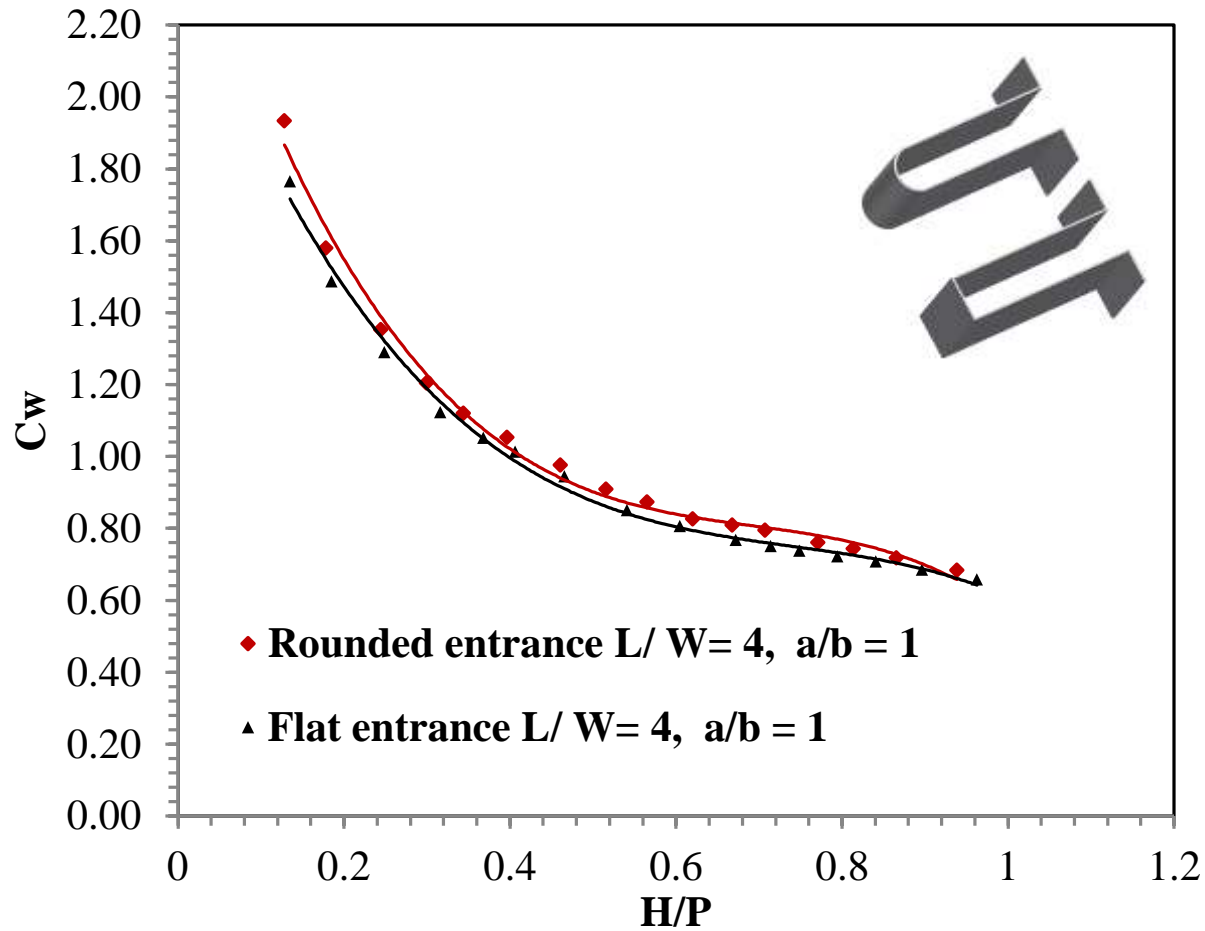

Discharge coefficient obtained from experimental tests for the entrance effect

- Entrance Effect

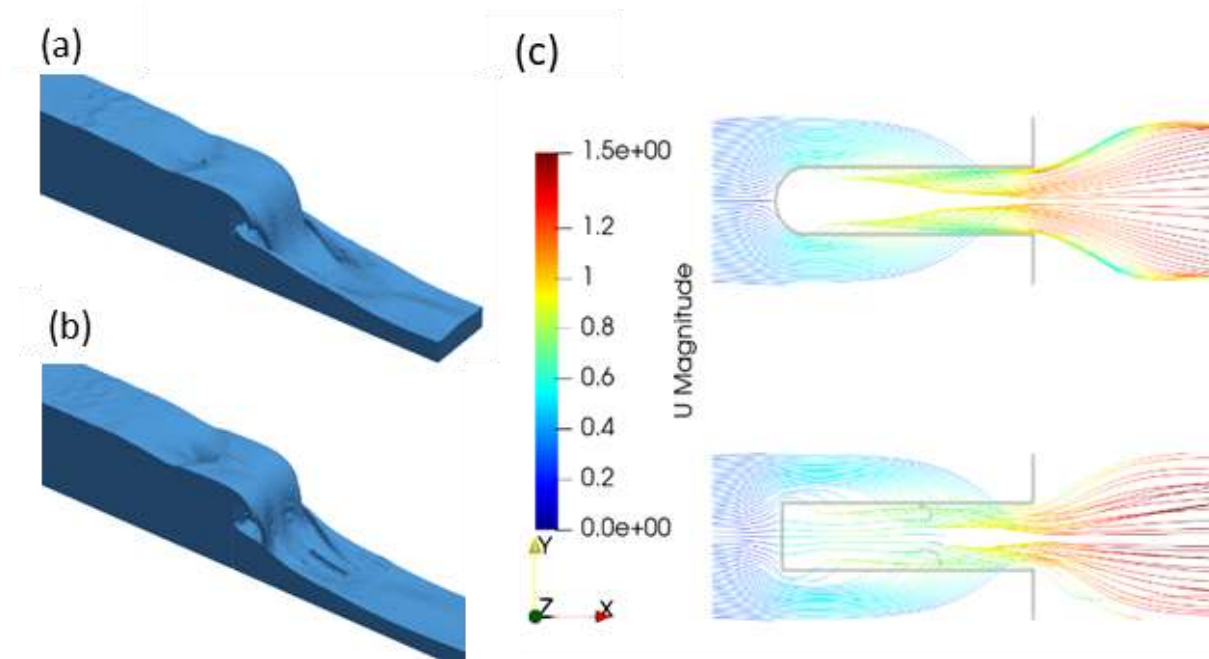

3D flow profile (a, b) and streamlines (c) over simulated models

- Entrance Effect

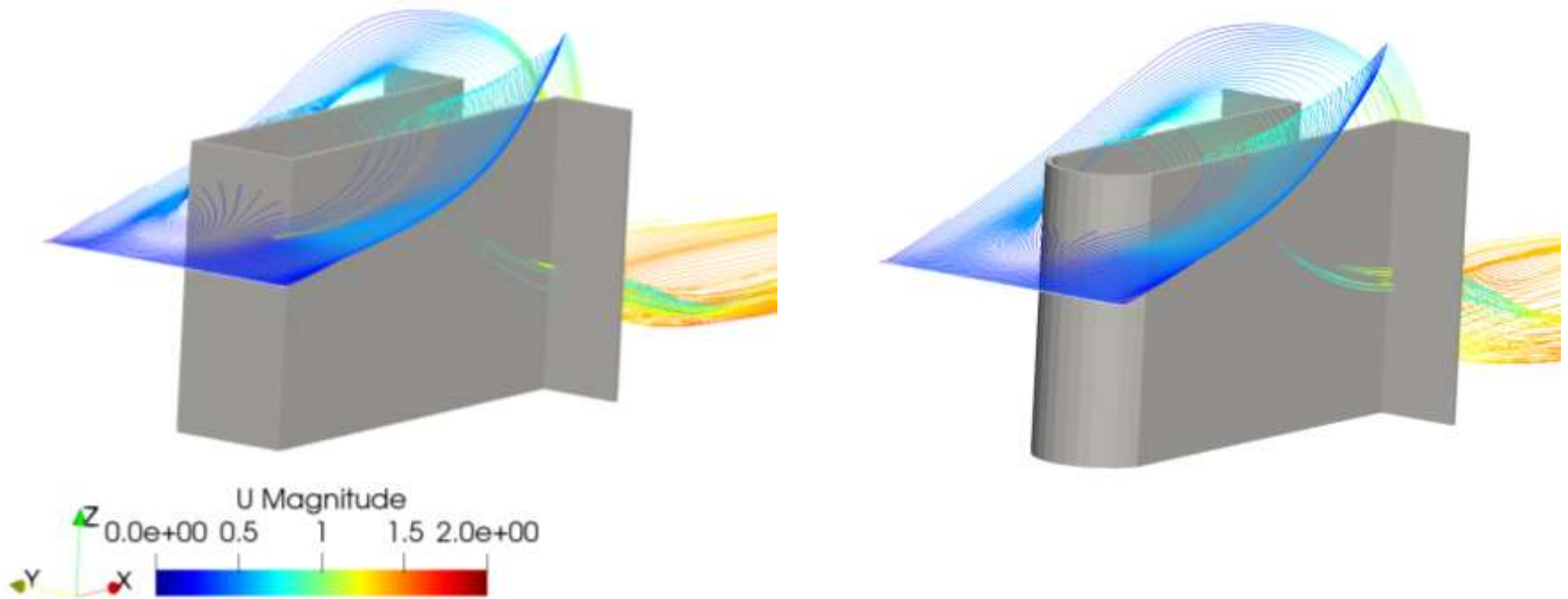

Streamlines near the crest of the simulated models

- Effect of the developed crest length

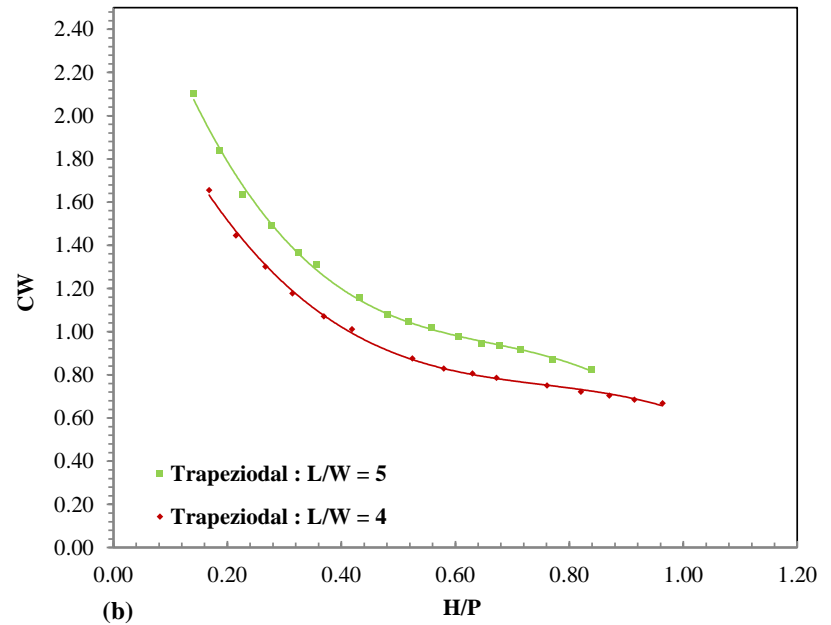
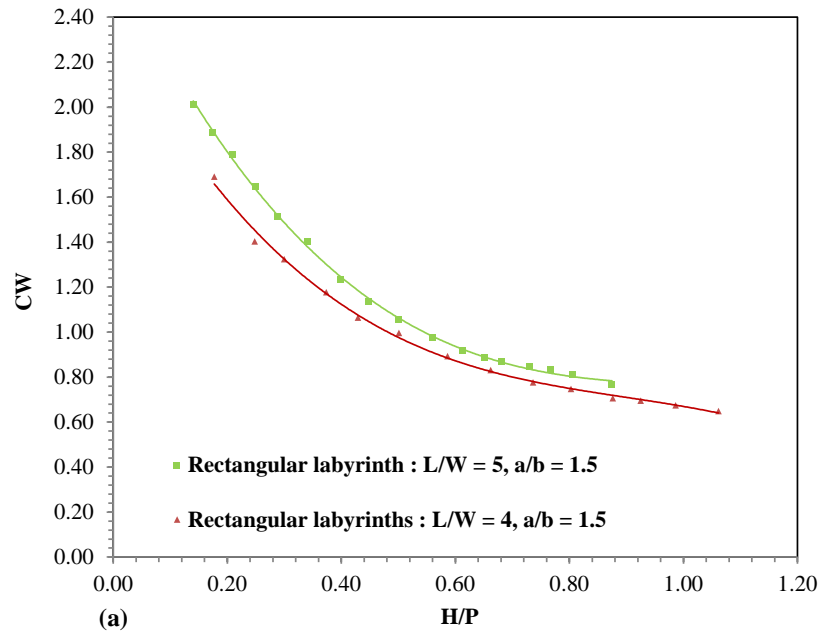

Experimental results of crest length effect: (a) Rectangular labyrinth, (b) Trapezoidal labyrinth.

- Effect of the developed crest length

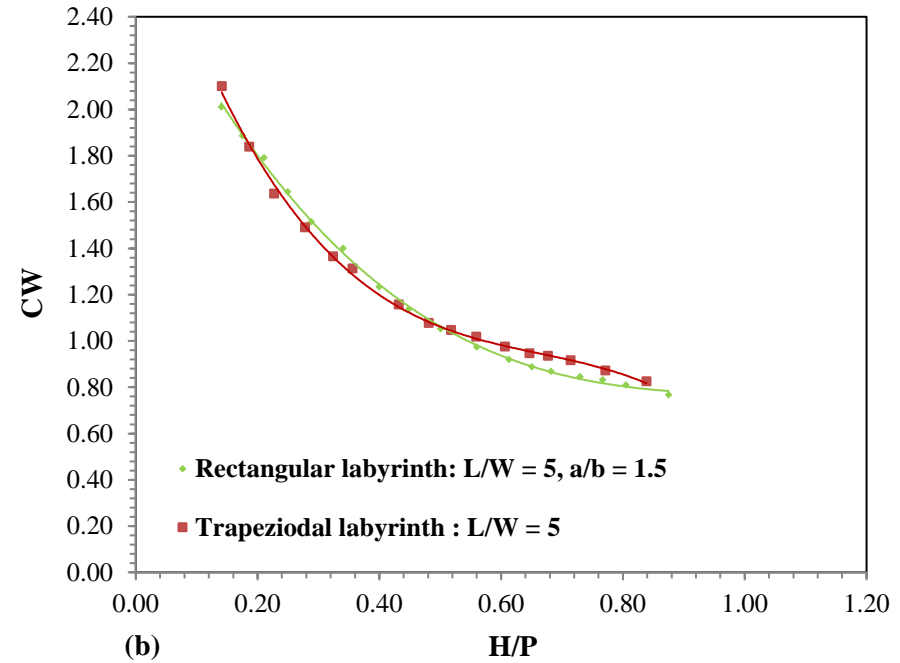
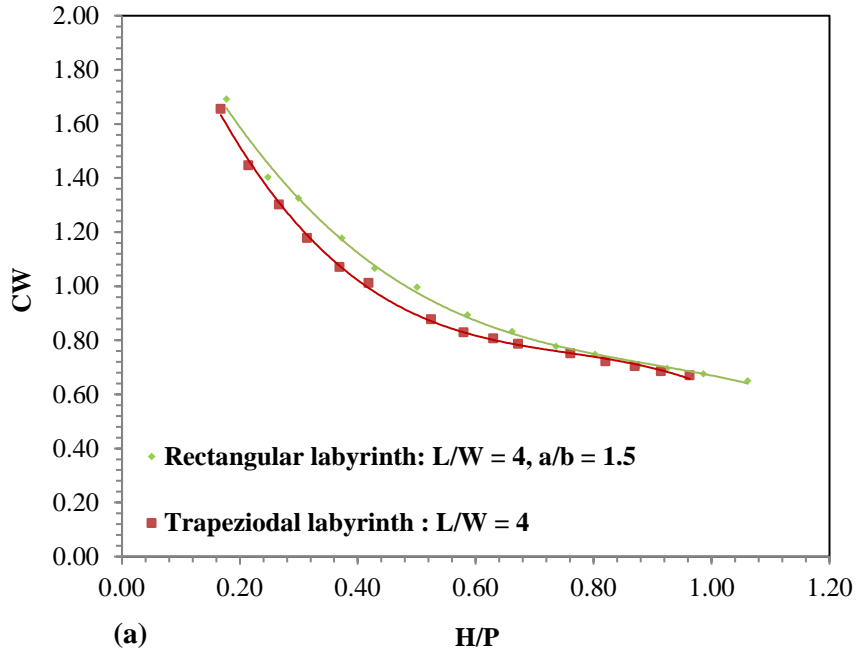

Experimental results of the developed crest length effect: (a) for $L/W = 4$, (b) for $L/W = 5$)

- Effect of the developed crest length

(a)

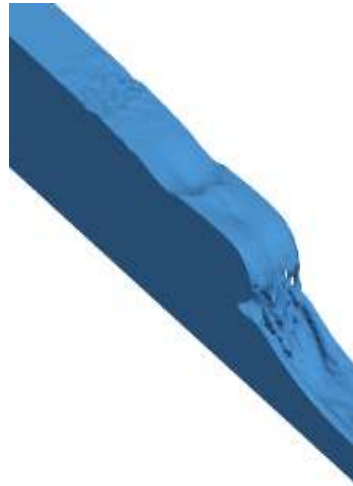

(b)

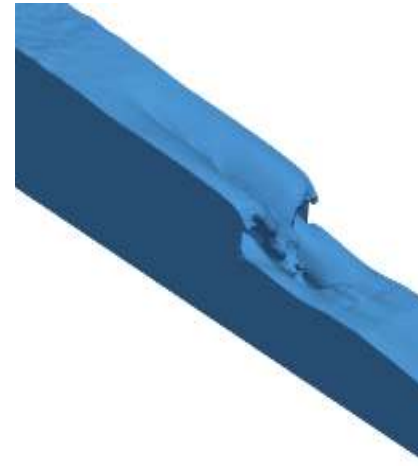

Water surface profile for $H/P = 0.35$, (a) rectangular with $L/W = 5$, (b) trapezoidal with $L/W=5$.

- Effect of the developed crest length

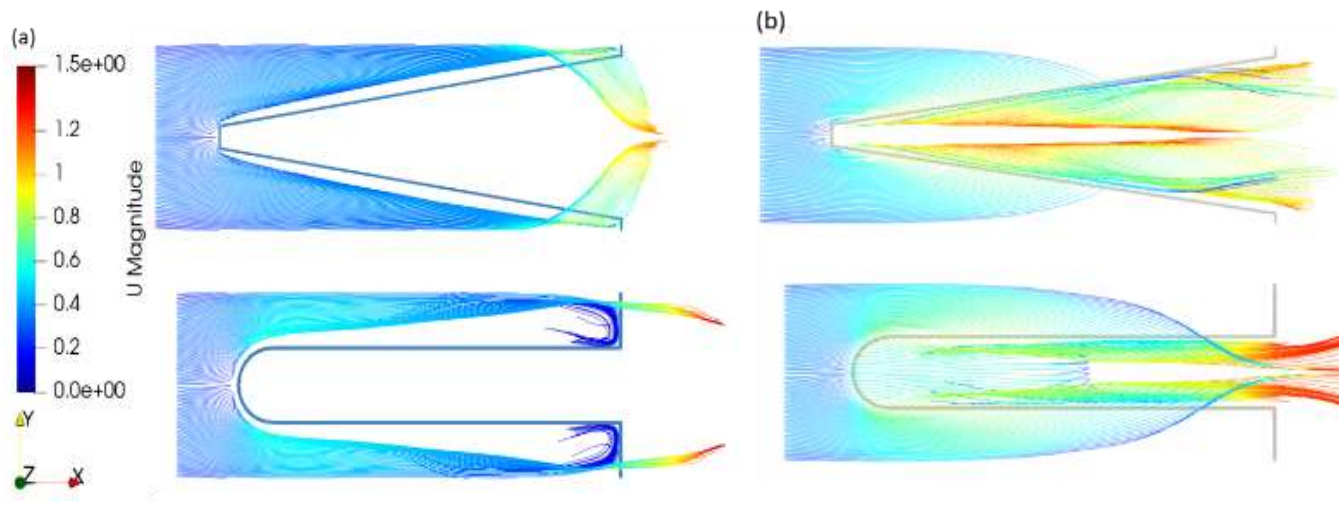

Streamlines over labyrinth weir for $H/P = 0.35$ for labyrinth with $L/W=5$, (a) near the bottom, (b) near the crest for

- Effect of the developed crest length

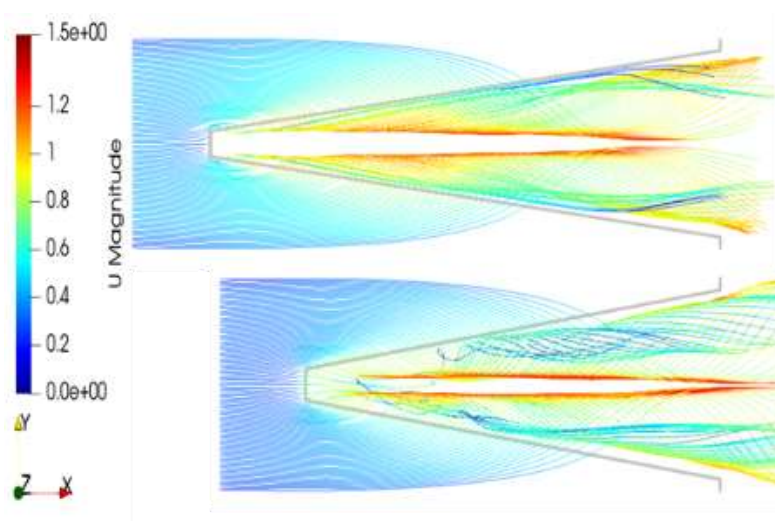

Streamlines at the crest of the labyrinth for both ratios, $L/W = 4$ and $L/W = 5$.

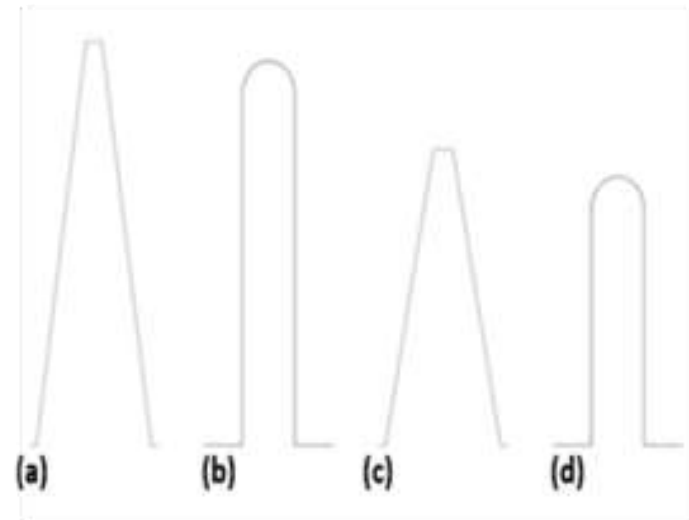

View from top, trapezoidal with $L/W = 5$ (a), Rectangular with $L/W = 5$ (b), Trapezoidal with $L/W = 4$ (c), and Rectangular with $L/W = 4$.

- Effect of the overhangs design

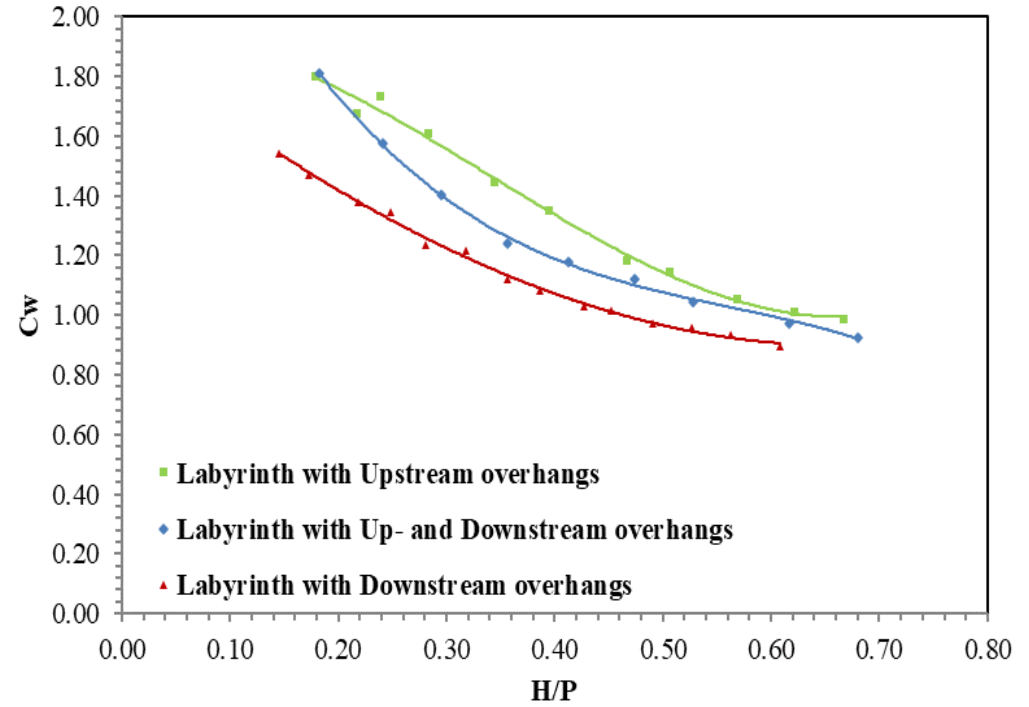
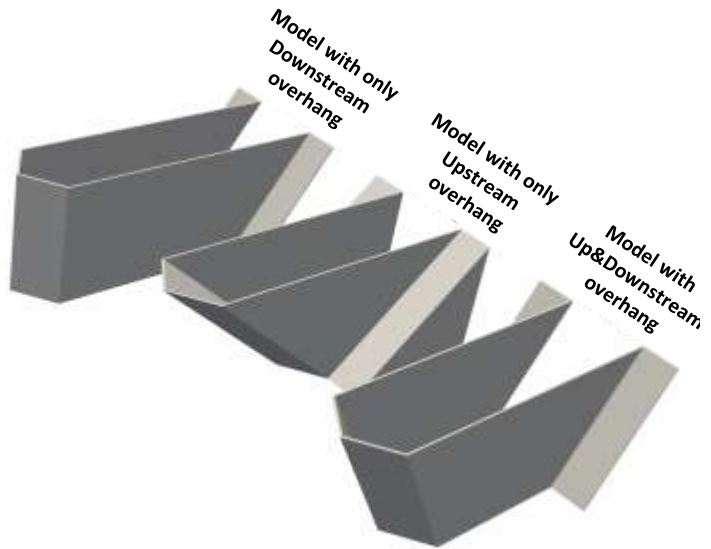

Experimental results of the effect of the geometry of the overhangs

- Effect of the overhangs design

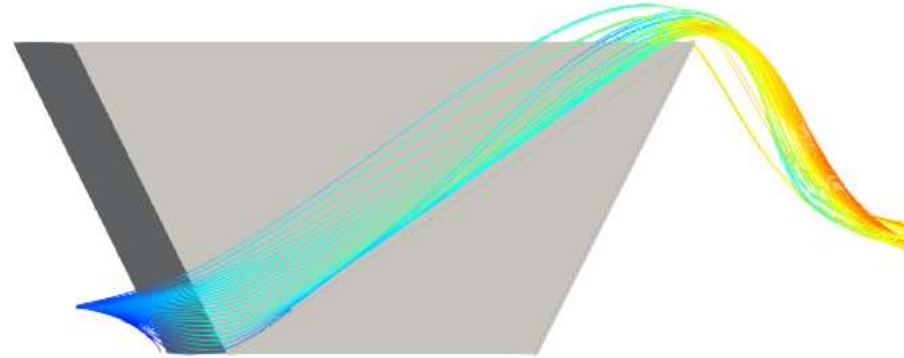
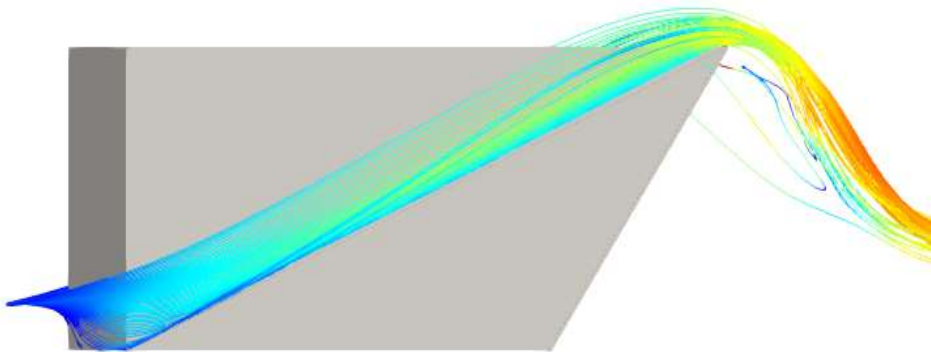
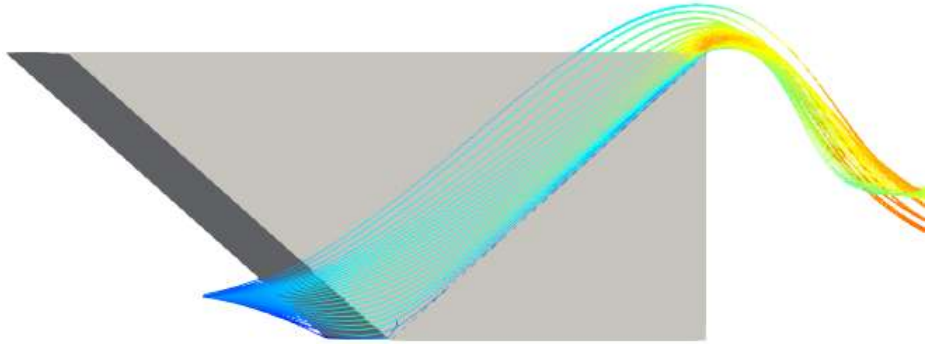

Streamlines at the bottom of the simulated weirs

- Effect of the overhangs design

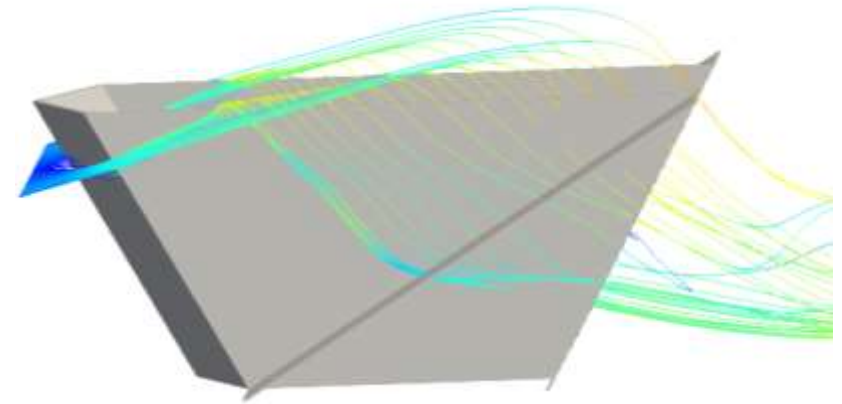
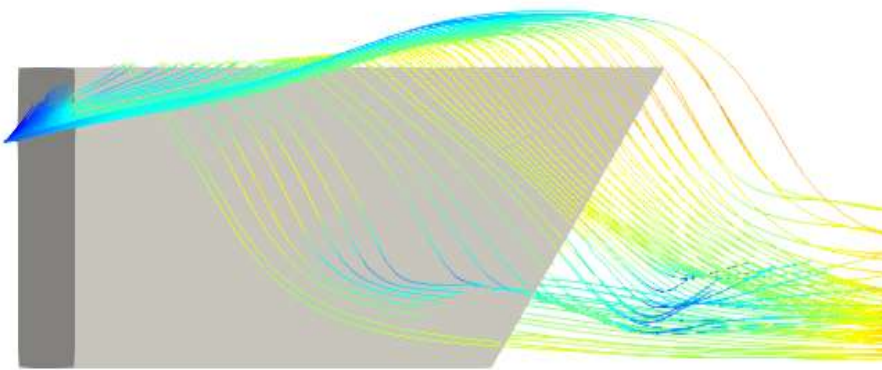
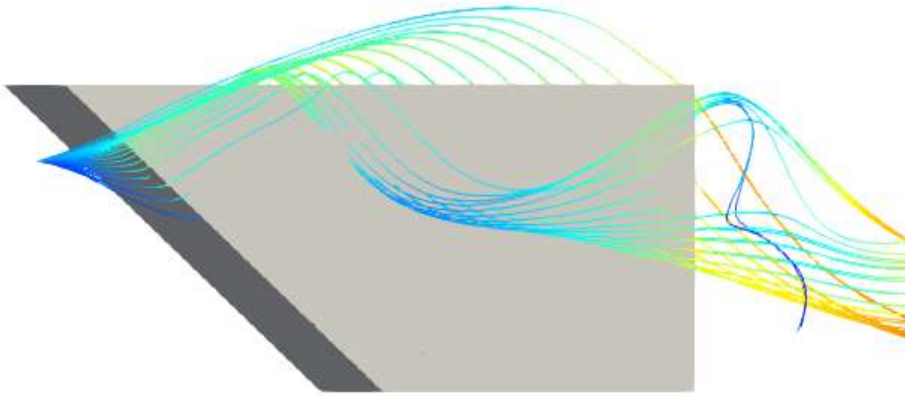

Streamlines near the crest of the simulated weirs

- The entrance shape of the rectangular labyrinth weir has an effect on the labyrinth weir capacity. The use a rounded entrance enables to increase the discharge capacity by 5%.
- The obtained results have shown that the rectangular labyrinth weir provides higher discharge capacity compared to the trapezoidal labyrinth weir, mainly for $L/W=4$.
- The findings suggested that the enhanced configuration of the labyrinth weir could be employed to enhance the discharge capacity without incurring any additional expenses.
- Combining experimental and numerical approaches can greatly enhance comprehension, analysis, and optimization of the nonlinear performance.

Conclusion

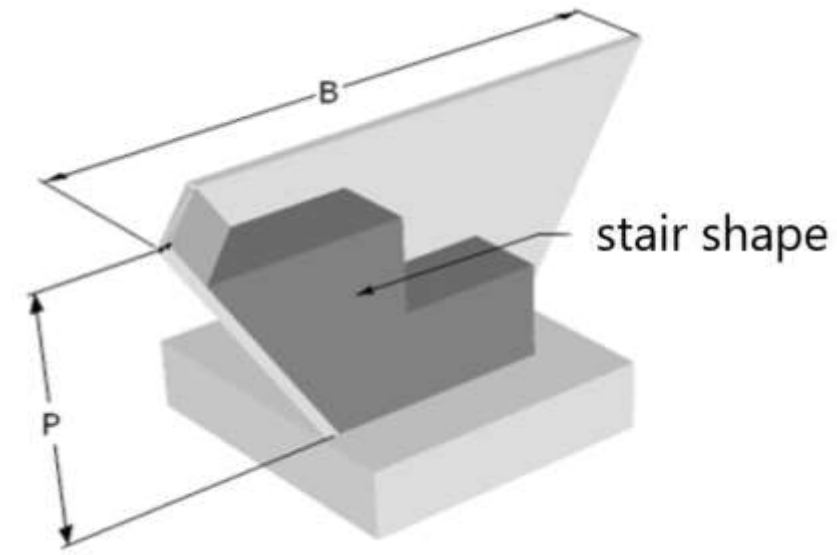
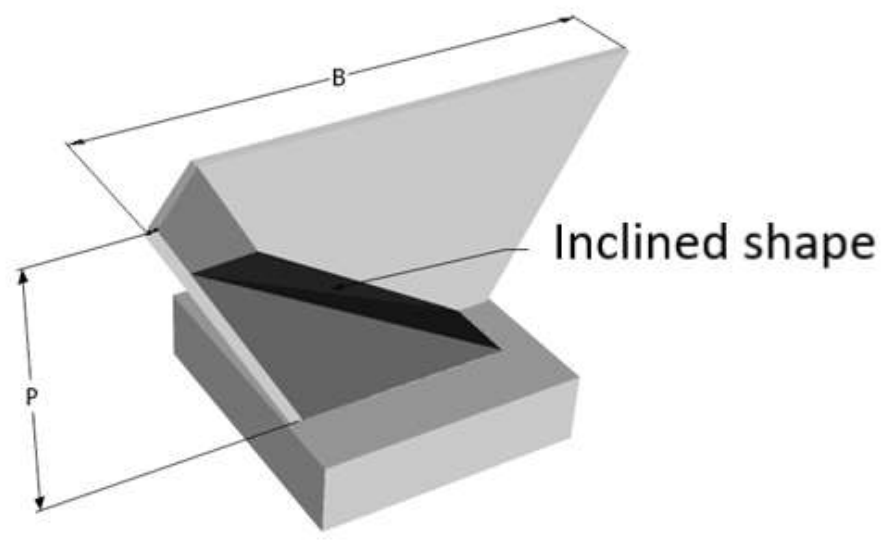
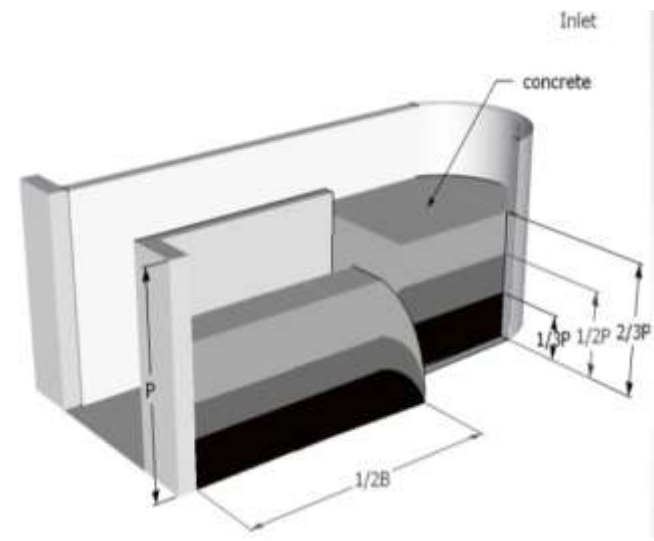
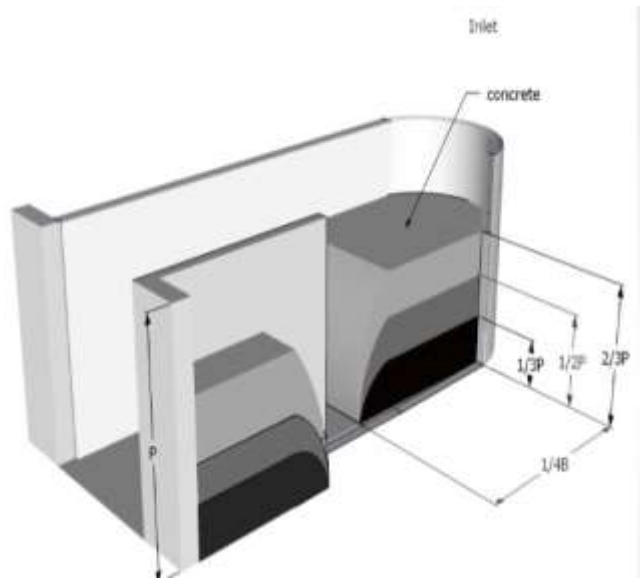

Conclusion

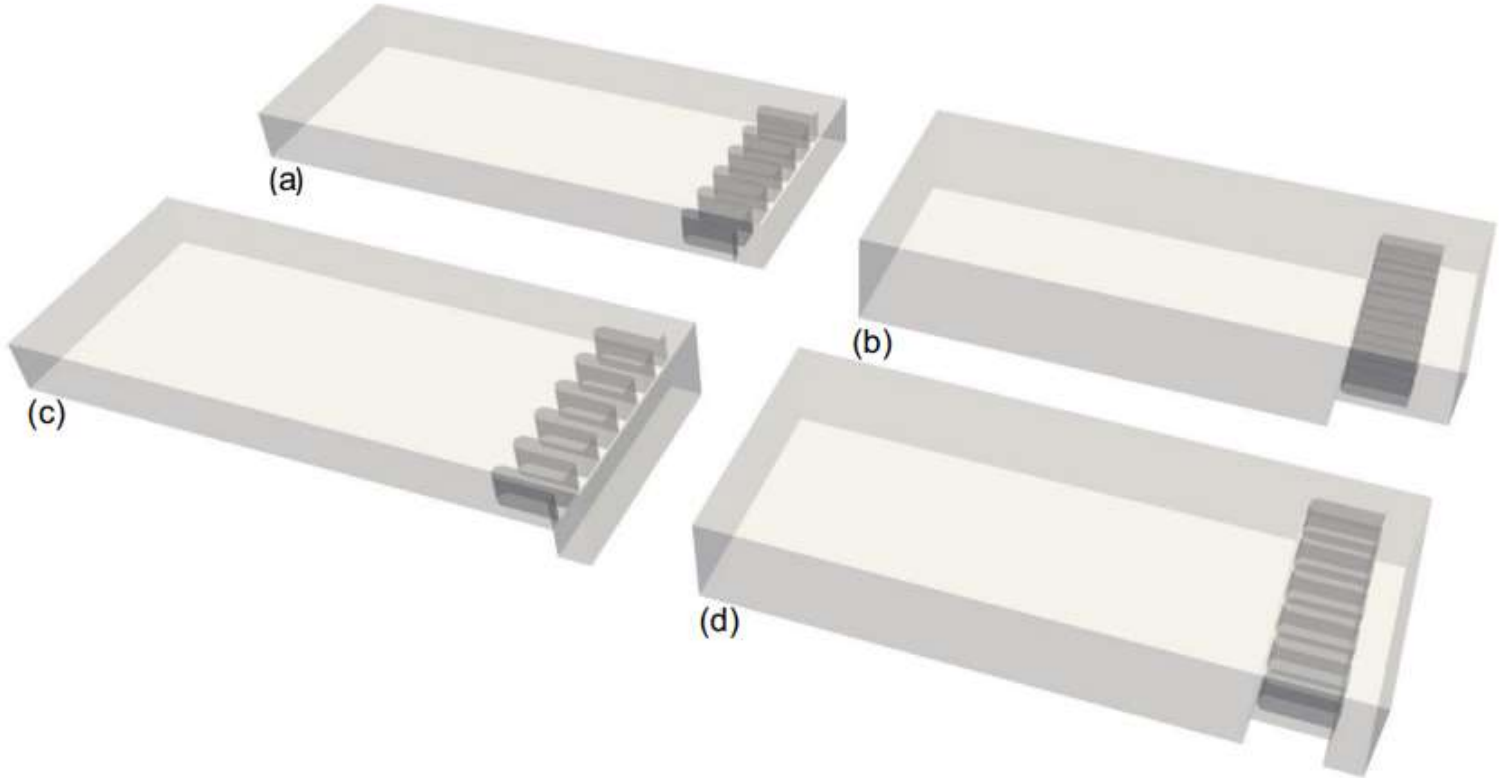

Thank you